

# KWV-TEC TRIMMED ACOUSTICAL TECHNICAL DATA

Individual Panels/Multi-Directional  
STC 35

## **KWIK-WALL... One Source for Wall Systems.**

KWIK-WALL's KWV-Tec Series - Glass wall systems answer the challenge for space division needs. This system ensures you can quickly and easily provide complete solutions for space division needs in hotels, churches, schools, airports, residential layouts, shopping centers, sports arenas, and office buildings. Years of continuing research and development have produced many outstanding features.

KWIK-WALL's KWV-Tec - Trimmed Acoustical STC 35 model offers maximum versatility in sliding and stacking arrangements, utilizing individually operated panels with a track system that can provide 90°, "X", "L", and "T" intersections for nearly unlimited layout possibilities. The KWV-Tec Trimmed combines the elegant horizontal top and bottom glass retainer, used in other Clear-Divisions models with the multi-directional Type 425 Track and carrier system. This model has a trimmed frame for enhanced security and rigidity which also reduces drafts.

## **FEATURES**

- Elegant top-fixed suspension and glass retainer
- One (1) standard and four (4) optional glass finish styles
- Multiple stacking arrangements
- Secure locking system

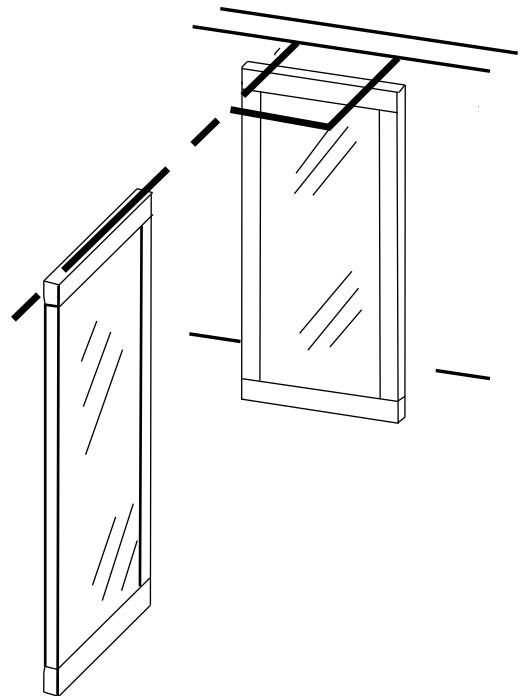

### 1.01 WORK INCLUDED

- A. Moveable glass wall system shall be furnished, installed, and serviced by KWIK-WALL's authorized distributor, in compliance with the architectural drawings and specifications contained herein.

### 1.02 RELATED WORK

- A. Structural Support: Structural support system required for suspending the moveable glass wall shall be designed, installed, and pre-punched by others, in accordance with ASTM E 557 and KWIK-WALL's shop drawings.
- B. Opening Preparation: Proper and complete preparation of the moveable glass wall system opening shall be by others in accordance with ASTM E 557, and shall include floor leveling; plumbness of adjoining permanent walls; substrate and / or ceiling tile enclosures for the track system; and the painting and finishing of trim and other materials adjoining the head and jamb areas of the moveable glass wall. Refer to a copy of the shop drawings for additional details.

### 1.03 SYSTEM DESCRIPTION

- A. The moveable glass wall system shall consist of Individual Panels that are top supported by two (2) multi-directional carriers that are capable of negotiating 90°, "X", "L", and "T" intersections.
- B. The moveable glass wall system shall consist of nominal 1/2" [12.7] thick laminated glass panels suspended from a continuous aluminum glass retainer located at the top and bottom of each panel.

### 1.04 QUALITY ASSURANCE

- A. Installer Qualifications: An experienced installer who is certified in writing by KWIK-WALL as qualified to install KWIK-WALL's systems for work similar in material, design, and extent to that indicated for this project.
- B. The moveable glass wall panel shall utilize clear laminated glass per ASTM C 1172-03.
- C. The moveable glass wall shall be installed by KWIK-WALL's authorized distributor in accordance with ASTM E 557.
- D. The glass wall panel construction and finish materials shall consist of Class A rated materials in accordance with ASTM E 84.

### 1.05 REFERENCES

- A. ASTM C 1036-01: Standard Specification for Flat Glass.
- B. ASTM C 1048-04: Standard Specification for Heat Treated Flat Glass.
- C. ASTM E 557: Architectural Application and Installation of Operable Partitions.
- D. ASTM C 1172-03: Standard specifications for laminated architectural flat glass.
- E. ASTM E 90: Laboratory Measurement of Airborne-Sound Transmission Loss of Building Partitions.
- F. ASTM E 413: Determination of Sound Transmission Class (STC).

### 1.06 SUBMITTALS

- A. KWIK-WALL shall provide written technical information and related detail drawings, which demonstrate that products comply with contract documents for each type of moveable glass wall system specified.
- B. KWIK-WALL shall provide detailed engineering drawings featuring track plan, panel elevation, horizontal and vertical details and beam punching template as required.
- C. Manufacturer shall provide written instructions specifying the proper operation and maintenance of the moveable glass wall system.
- D. Manufacturer shall provide a color selector demonstrating the manufacturer's selections of the specified hardware finish.
- E. Manufacturer shall provide written test report of the independent acoustical testing laboratory certifying the attainment of the specified STC rating, upon request.

### 1.07 DELIVERY, STORAGE AND HANDLING

- A. Panels shall be shipped in a completely enclosed wooden crate with high-density polystyrene blocks positioned between each panel to protect glass and hardware during delivery, storage and handling.
- B. Panels shall be stored on edge and above the floor on cushioned blocking in a dry and ventilated area, protected from humidity and temperature extremes.

### 1.08 SEQUENCING / SCHEDULING

- A. Beam Punching: KWIK-WALL shall provide beam punching template drawing detailing the anchor locations for the suspended track system for Drop Rod Mounting, as required for the fabrication and installation of structural overhead support by others.
- B. Track Installation: Scheduling of moveable glass wall track installation shall occur after structural overhead support has been properly and completely fabricated and installed by others.
- C. Panel Installation: Moveable glass wall panel installation shall occur after fixed wall substrate construction is properly and completely installed by others, as required to protect panels from ongoing adjacent construction.

### 1.09 WARRANTY

- A. KWIK-WALL shall warrant each moveable glass wall system and its hardware components to be free from defects in material and workmanship for a period of five (5) years from the date of delivery to the original purchaser, when installed by an authorized KWIK-WALL distributor. (Glass is specifically excluded from the warranty.)

## 2.01 ACCEPTABLE MANUFACTURER

- A. Moveable glass walls shall be CLEAR-DIVISIONS KWV-Tec - TRIMMED ACOUSTICAL Individual Panels as manufactured by KWIK-WALL Company.

## 2.02 PANEL CONSTRUCTION

- A. Panel Dimensions: Standard panel dimension shall be a nominal 1 7/16" [36.5] thick.
- B. Perimeter Door Frames: Top and bottom rails and vertical stiles shall be continuous one-piece extrusion manufactured of structural grade aluminum as engineered by Hawa® with removable end caps.
- C. Bottom Rail Locking System: Each bottom rail glass retainer shall contain (select):
1. Standard Thumb Turn Lock: Consisting of an operable floor lock operated by a thumb turn that engages a recessed spring loaded dust-proof strike to provide stability and security when the moveable glass wall system is extended.
  2. Optional Keyed / Thumb Turn Lock: consisting of key operated cylinders on both sides or key operation on one (1) side and thumb turn operation on opposite side.
  3. Optional Operable Floor Lock: consisting of a Face-activated foot lock located on one (1) side of the panel that engages a recessed spring loaded dust-proof strike to provide stability and security when the moveable glass wall system is setup in the extended position
- D. Glass: Panels shall be glazed with 1/2" [12.7] laminated glass that is manufactured in accordance with ASTM C 1036-01, ASTM C1172-03 and ANSI Z 97.1. Glass finish shall be (select)
1. Standard Clear: consisting of laminated glass (select):
    - a. 1/2" [12.7] thick glass for Panel Heights up to 10'-6" (3.2 m).
  2. Optional Glass writable surface,
    - a. 1/2" [12.7] thick glass for Panel Heights up to 10'-6" (3.2 m).
  3. Optional Sandblasted: consisting of laminated glass (select):
    - a. 1/2" [12.7] thick glass for Panel Heights up to 10'-6" (3.2 m).
  4. Optional Opaque: consisting of laminated glass (select):
    - a. 1/2" [12.7] thick glass for Panel Heights up to 10'-6" (3.2 m).
- E. Panel Weight: Maximum panel weight shall not exceed 330 lb. (150 kg) calculated at 8.33 lb. / ft.<sup>2</sup> (40.65 kg / m<sup>2</sup>).

## 2.03 OPERATION

- A. Operation shall be Individual Panels with a Multi-Directional track system, that allows the panels to negotiate 90°, "X", "L", and "T" intersections as required for movement of panels from storage location(s) to various installed positions. Panels shall be top supported by two (2) carriers featuring dual horizontal precision bearings with high strength polymer tires riding on a structural aluminum track.

## 2.04 STACK ARRANGEMENTS

- A. Stack Type: Panel storage configuration shall be (select):
1. Standard Perpendicular Stack: consisting of panels stacking at a 90° angle perpendicular to the wall's installed position.
  2. Optional Parallel Stack: consisting of panels stacking parallel to the wall's installed position.

Note: Parallel stacking configuration may not be possible in every application. Due to minimum stacking / pocket clearances required, prior approval of the parallel stacking configuration shall be approved by KWIK-WALL.

3. Optional Remote Stack: consisting of panels located remotely from the wall's installed position, as shown on the submitted shop drawings.

- B. Stack Quantity: Panels shall be stored in designated stack area as required for panel storage.

## 2.05 FINISHES

- A. Hardware Finish: Panel hardware including horizontal rails shall be finished of (select):
1. Standard Finish: Clear Anodized Aluminum.
  2. Optional Finish: Custom Anodized per supplied sample.
  3. Optional Finish: Powder Coated Paint to any RAL code.
- B. Pull Handle Finish: Handle finish shall be (select):
1. Standard Finish: consisting of Stainless Steel Satin finish.
  2. Optional Finish: consisting of Pull Handle to match Hardware Finish selection (as close as possible).

## 2.06 PERIMETER TRIM AND SEALS

- A. Trim and Seals shall consist of (select):
1. Standard Trimmed: consisting of 1/2" [12.7] laminated glass with a sanded / beveled edge utilizing a full vertical extruded aluminum astragal containing a continuous contact, flexible rubber seal installed along the Lead vertical edge of each panel. Aluminum astragal shall encapsulate the edge of the glass for enhanced security and rigidity.
  2. Standard Horizontal Top: consisting of continuous contact black vinyl seals provided on both sides of each panel.
  3. Standard Bottom Seal: consisting of continuous contact black vinyl seals provided on both sides of each panel.

## 2.07 CLOSURE SYSTEMS

- A. Initial Closure System: The lead panel (the first panel exiting the stack) shall form a seal against an Adjustable Starter Jamb shall consist of an aluminum extrusion that is permanently mounted to a structural wall surface and is field-adjustable to compensate for out-of-plumb conditions of the fixed wall.
- B. Final Closure System: The final closure panel (the last panel at the stack end) shall provide a method for affecting final closure of the moveable glass wall system. The type of final closure panel shall be (select):
1. Standard Fixed Pivot Panel Closure: consisting of a panel utilizing top and bottom pivots that allows the panel to pivot 90° in one (1) direction and be used to affect final closure, and provides access thru the moveable glass wall

system when it is setup in the extended position. The trail edge of the Fixed Pivot Panel shall contain a continuous contact, flexible rubber seal that interfaces with aluminum Adjustable Wall Jamb. The wall jamb shall be permanently mounted to a structural wall surface and is field-adjustable to compensate for out-of-plumb conditions of the fixed wall. One (1) side of the final closure panel shall contain a pull handle. (Refer to Part 2.05 "B. Pull Handle Finish".)

Note: Pivot Panel may not be required. Consult your KWIK-WALL representative for proper configuration. See page 7 for details.

2. Optional Fixed Swing Panel Closure: consisting of a panel utilizing top pivot and bottom pivot that engages with a self-closing unit containing a hold-open feature that is recessed flush into the floor allowing the panel to pivot 90° in one (1) direction and be used to affect the final closure, and provides access thru the moveable glass wall system when it is setup in the extended position. The trail edge of the Fixed Swing Panel shall contain a continuous-contact, flexible rubber seal that interfaces with aluminum Adjustable Wall Jamb. The wall jamb shall be permanently mounted to a structural wall surface and is field adjustable to compensate for out-of-plumb conditions of the fixed wall. One (1) side of the final closure panel shall contain a pull handle. (Refer to Part 2.05 "B. Pull Handle Finish".)

## 2.08 ACOUSTICAL PERFORMANCE

- A. Certification: The operable wall shall have been tested in an independent acoustical testing laboratory in accordance with ASTM E 90 and ASTM E 413 test procedures.
- B. STC Rating: The operable wall acoustical performance rating shall be based on (select):
  1. Standard acoustical substrate: with a standard rating of 35 STC

## 2.08 PANEL ACCESSORIES

- A. Accessories including a Floor Guide Channel shall be compatible with other accessories and options, furnished by KWIK-WALL as noted on submitted shop drawings.
  1. Floor Guide Channel: consisting of a clear anodized extruded aluminum channel that is recessed into the floor (flush with finished floor) to provide additional stability to panels as they are moved in and out of their storage location.

## 2.09 TRACK SYSTEM

- A. The KWV-Tec TRIMMED glass wall track system shall be extruded from structural aluminum alloy, which prohibits deterioration caused by rust or corrosion. The aluminum track shall have a durable anodized clear satin finish, which resists color fading and flaking. The track shall utilize grooves and interlocking steel pins for positive alignment of adjacent track sections. The track joints shall be reinforced overhead by a heavy-duty steel bracket made of hot-rolled, 3/8" [10] thick plate steel. Aluminum track shall include an integral nut slot to accept a hardened steel square nut to facilitate attachment of each threaded steel all-rod and splice brackets to the overhead structural support.
- B. Track Size: The track size shall be Type 425 Multi-Directional Aluminum Track: certified to be capable of supporting up to 425 lbs. ( 193 kg ) of total live load weight per panel.

## 2.10 CARRIER SYSTEMS

- A. Carrier Type: Each individual panel shall be top supported by two (2) carriers utilizing a 5/8" [16] diameter pendant bolt. Each carrier shall consist of dual horizontal, permanently-lubricated, precision ground steel bearings with high strength polymer tires as required for smooth and quiet operation. Multi-Directional carriers shall be capable of negotiating 90°, "X", "L", and "T" intersections. As required for moving panels from storage location(s) to various installed positions.
- B. Carrier Size: The carrier size shall be:

1. Type 425 Multi-Directional Carrier: certified to be capable of supporting up to 425 lbs. ( 193 kg ) of total live load weight per panel

## 2.11 SUSPENSION SYSTEMS

- A. Mounting Systems: The KWV-Tec TRIMMED track system shall be supported by (select):
  1. Standard Drop Rod Mount: consisting of steel drop rod brackets with drop rods, consisting of adjustable rods of grade 2, 3/8" [10] diameter threaded steel all-rod provided with 3/8" [10] serrated steel nuts.
  2. Optional Direct Mount: consists of 3/8" [10] x 3" [76] lag screws for attachment to a level overhead structural (wood or steel) support.
  3. Optional Drop Rod Bracket Mount: consisting of 3/8" [10] thick steel brackets mounted to top flange of track and supported with adjustable rods of grade 2, 3/8" [10] diameter threaded steel all-rod provided with 3/8" [10] serrated steel nuts.

**3.01 INSPECTION**

- A. Proper and complete preparation of the moveable glass wall system opening shall be by others in accordance with the architectural drawings, KWIK-WALL's shop drawings and ASTM E 557. Any deviation of the actual opening from these specifications shall be called to the attention of the architect prior to the installation of the operable wall.
- B. Deficiencies in the moveable glass wall opening shall be corrected by others prior to installation of the moveable glass wall system.

**3.02 INSTALLATION**

- A. The moveable glass wall system shall be installed by KWIK-WALL's authorized distributor.
- B. The moveable glass wall shall be installed in accordance with KWIK-WALL's written instructions, shop drawings and ASTM E 557 installation guidelines.

**3.03 ADJUSTING AND CLEANING**

- A. The moveable glass wall panels and track system shall be adjusted and cleaned in accordance with KWIK-WALL's written instructions.

**3.04 PROTECTION**

- A. The moveable glass wall panels shall be stored in the stacked (retracted) position prior to acceptance by the owner's representative.

**3.05 DEMONSTRATION**

- A. KWIK-WALL's authorized distributor shall demonstrate proper operation and explain proper and necessary maintenance requirements of the moveable glass wall system to the owner's representative.

<b>KWV-Tec - TRIMMED ACOUSTICAL PRODUCT SELECTION GUIDE</b>							
<b>Model</b>	<b>Operation</b>	<b>Stack Arrangements</b>	<b>Glass</b>	<b>Perimeter Trim and Seals</b>	<b>Final Closure Options</b>	<b>Maximum Panel Height</b>	<b>Maximum Wall Width</b>
KWV-Tec Trimmed	Individual Panels	Standard: Perpendicular Optional: Parallel or Remote Stack	Standard: Clear Optional: Writing Surface, Opaque, Sandblasted	Trimmed	*Standard: Fixed Pivot Panel Optional: Fixed Swing Panel	**10' - 6" (3.2 m)	Unlimited
<b>STC Rating</b>	<b>Panel Thickness (nominal)</b>	<b>Maximum Panel Weight Lb./ft2</b>					
35	1 7/16" [36.5mm]	330 lb. 150kg.					

\*Pivot Panel may not be required. Consult your KWIK-WALL representative for proper configuration.

\*\* Contact Kwik-Wall if additional height is required.

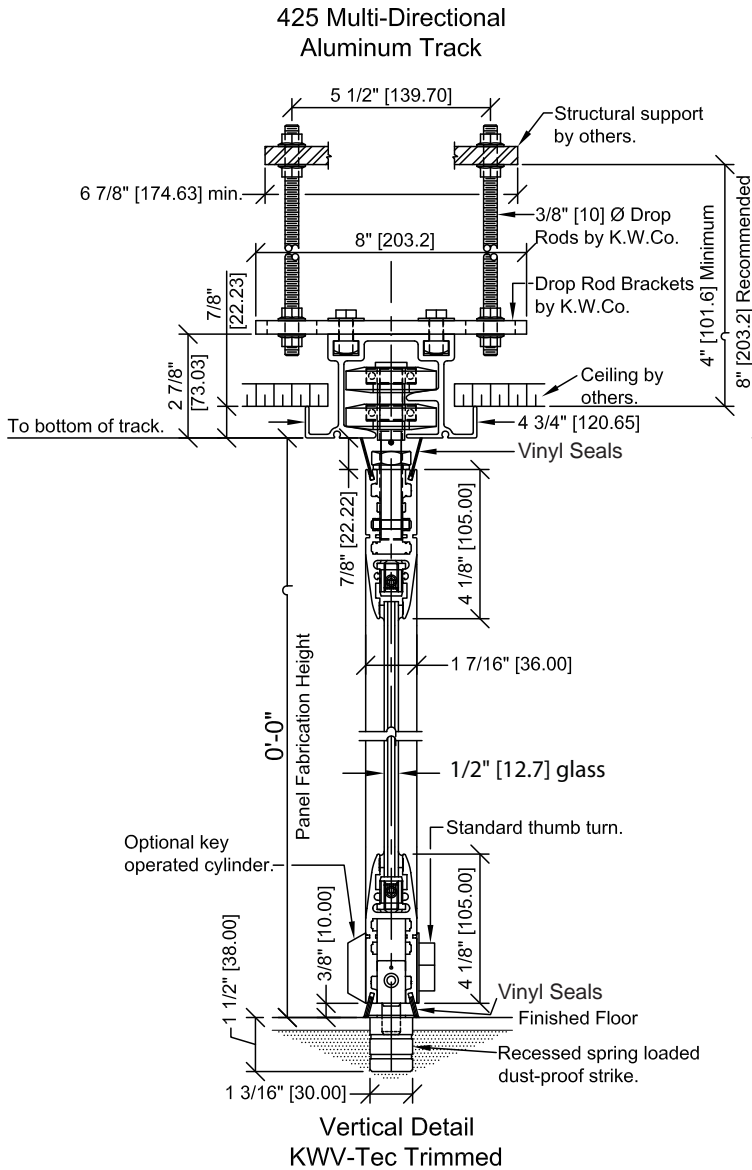

**Drop Rod Bracket Mount  
KWV-Tec Trimmed  
Acoustical**

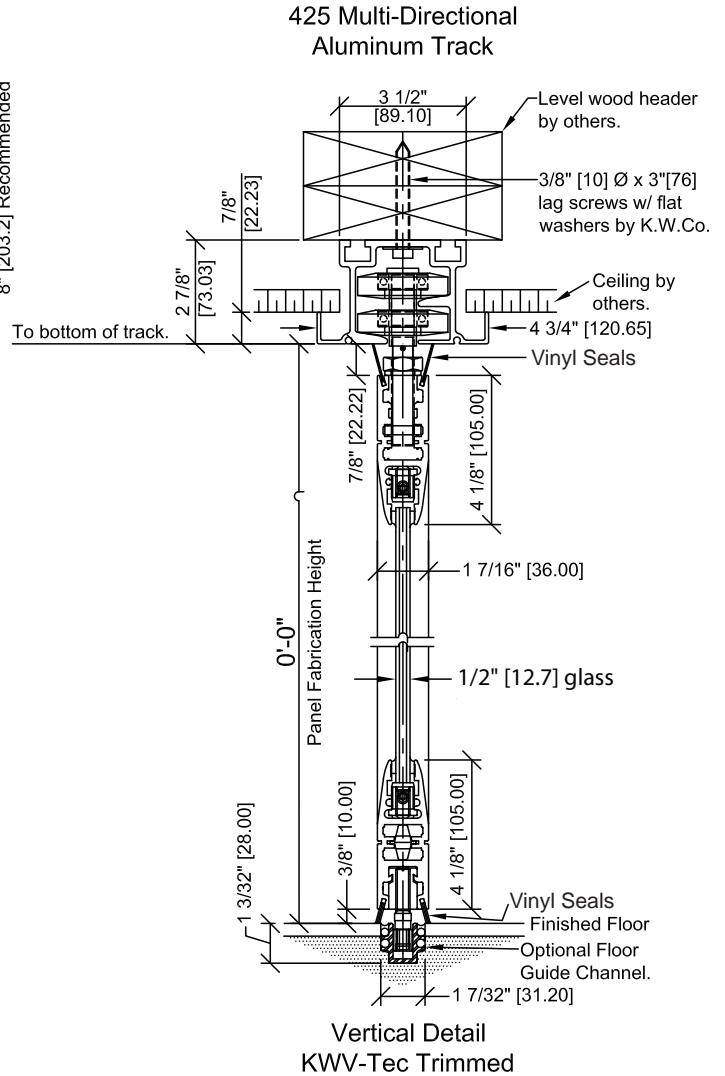

**Direct Mount with Floor  
Guide Channel  
KWV-Tec Trimmed  
Acoustical**

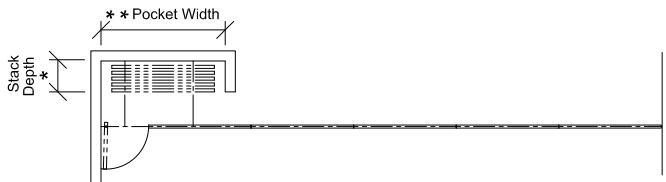
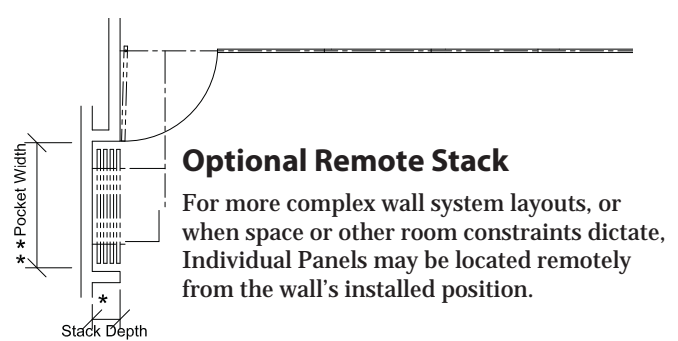
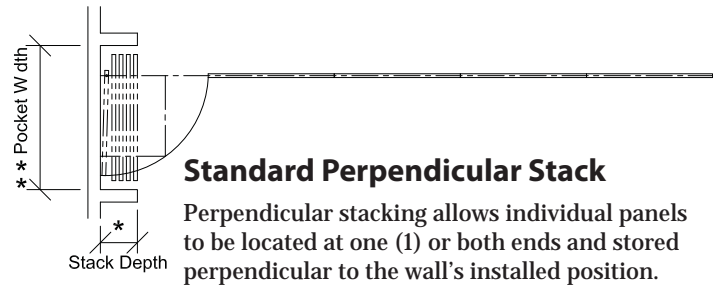

Note: Parallel stacking configuration may not be possible in every application. Due to minimum stacking / pocket clearances required. Prior approval of the parallel stacking configuration shall be approved by KWIK-WALL.

### Stack Depth\*

The overall depth of the stack area, as required for panel storage, is dictated by the total number of panels in the wall system. KWIK-WALL's KWV-Tec - Trimmed panels require an average stack depth of 2<sup>3</sup>/<sub>4</sub>" [70] per panel. To determine the stack depth, calculate as follows:

$$\text{Number of Panels} \times 2\frac{3}{4}'' [70] + \frac{3}{4}'' [18]$$

\*Note: Additional stack depth is required for wall systems containing the following type of panels:

- Handle: 3<sup>1</sup>/<sub>2</sub>" [89]
- Pivot Panel(s) Closure: 2<sup>3</sup>/<sub>8</sub>" [60]
- Pocket Door(s): 6" [152]

\*\*For wall systems that include Pocket Doors, please reference KWIK-WALL's "Variotec" brochure for pocket layout dimensions and applications.

### Pocket Width\*\*

The width of the pocket is determined by the widest panel in the wall run. For specification purposes, assume the widest panel is 4'-0" (122 cm) maximum. Pocket width may be calculated as follows:

$$\text{Panel Width} + 7'' [178]$$

(allows 3<sup>1</sup>/<sub>2</sub>" [89] for hand clearance on each side)

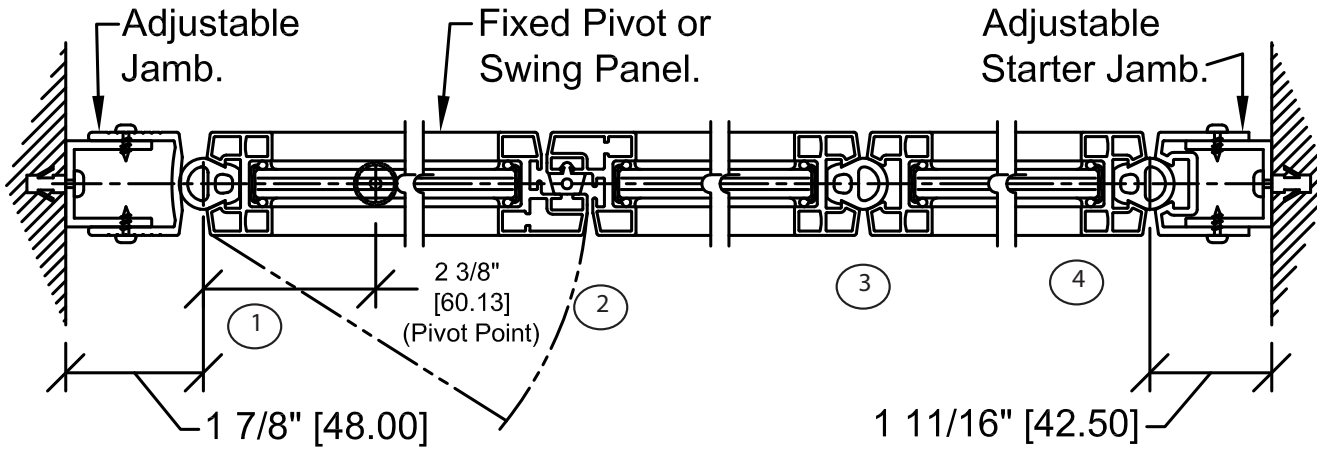

HORIZONTAL DETAIL  
KVV-Tec TRIMMED Acoustical

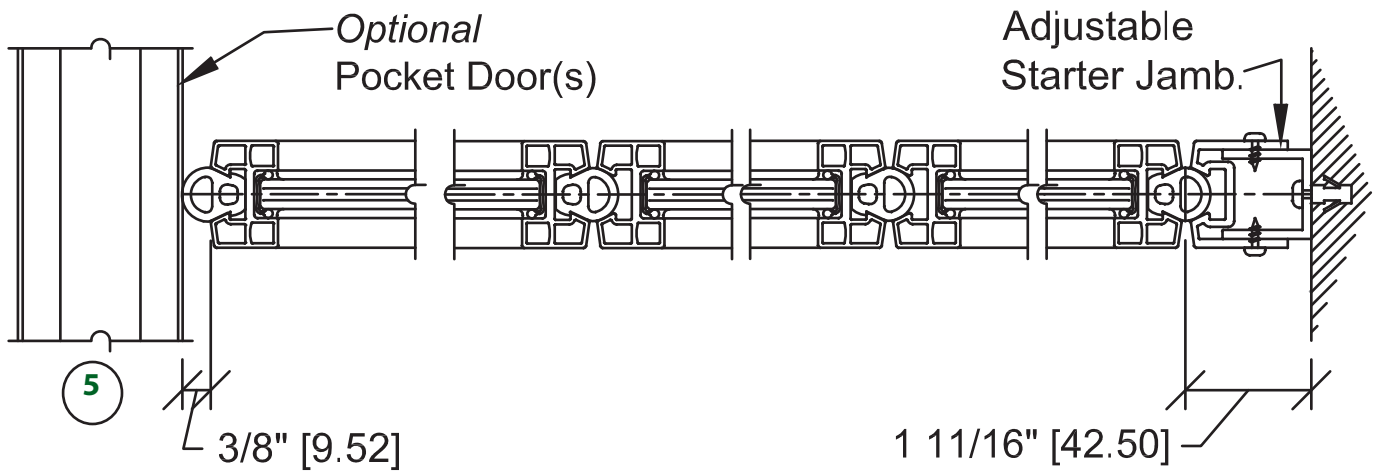

HORIZONTAL DETAIL  
KVV-Tec TRIMMED Acoustical



### Standard Fixed Pivot Panel

Consisting of a panel utilizing top and bottom pivots that allows the panel to pivot 90° in both directions. Provides access thru the wall system when setup is in extended position.

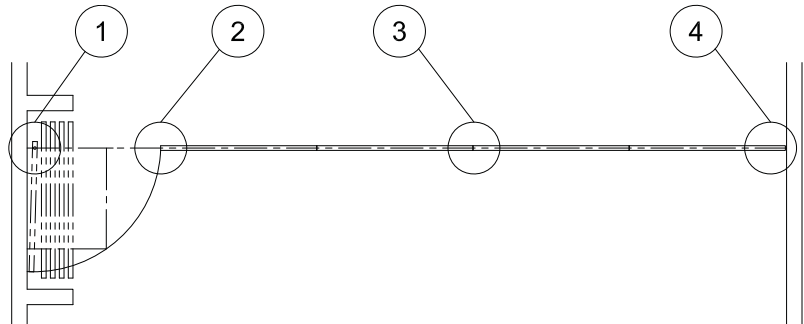

### Optional Fixed Swing Panel

Consisting of a panel utilizing top and bottom pivots that engages with a self-closing unit containing a hold open feature allowing the panel to pivot 90° in both directions. Provides access thru the wall system when setup is in extended position.

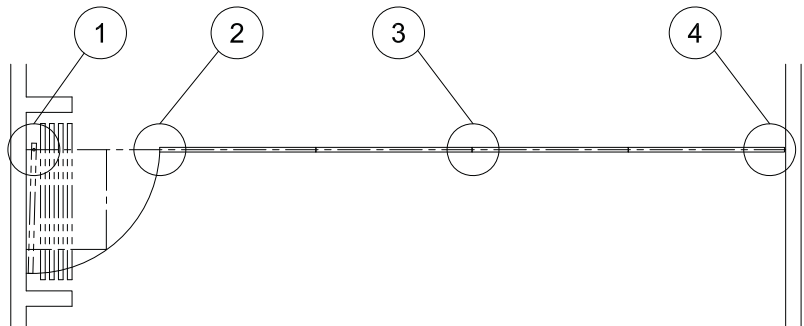

### Optional Single Sliding Pocket Door

Consisting of a single panel suspended by two (2) carriers traveling in an overhead track system. Bottom of panel shall contain a Door Guide attached to the floor to stabilize the panel. Panel shall contain a flush pull handle on both sides.

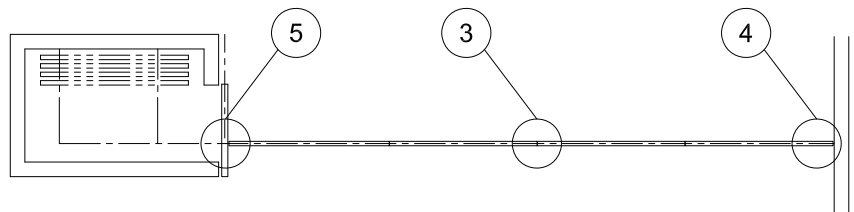

1. Pivot Door/Swing Door
2. Pivot meets Sliding Door
3. Typical Joint
4. Initial Closure Panel
5. Pocket Door

Horizontal details for numbers 1 through 5 can be found on page 8

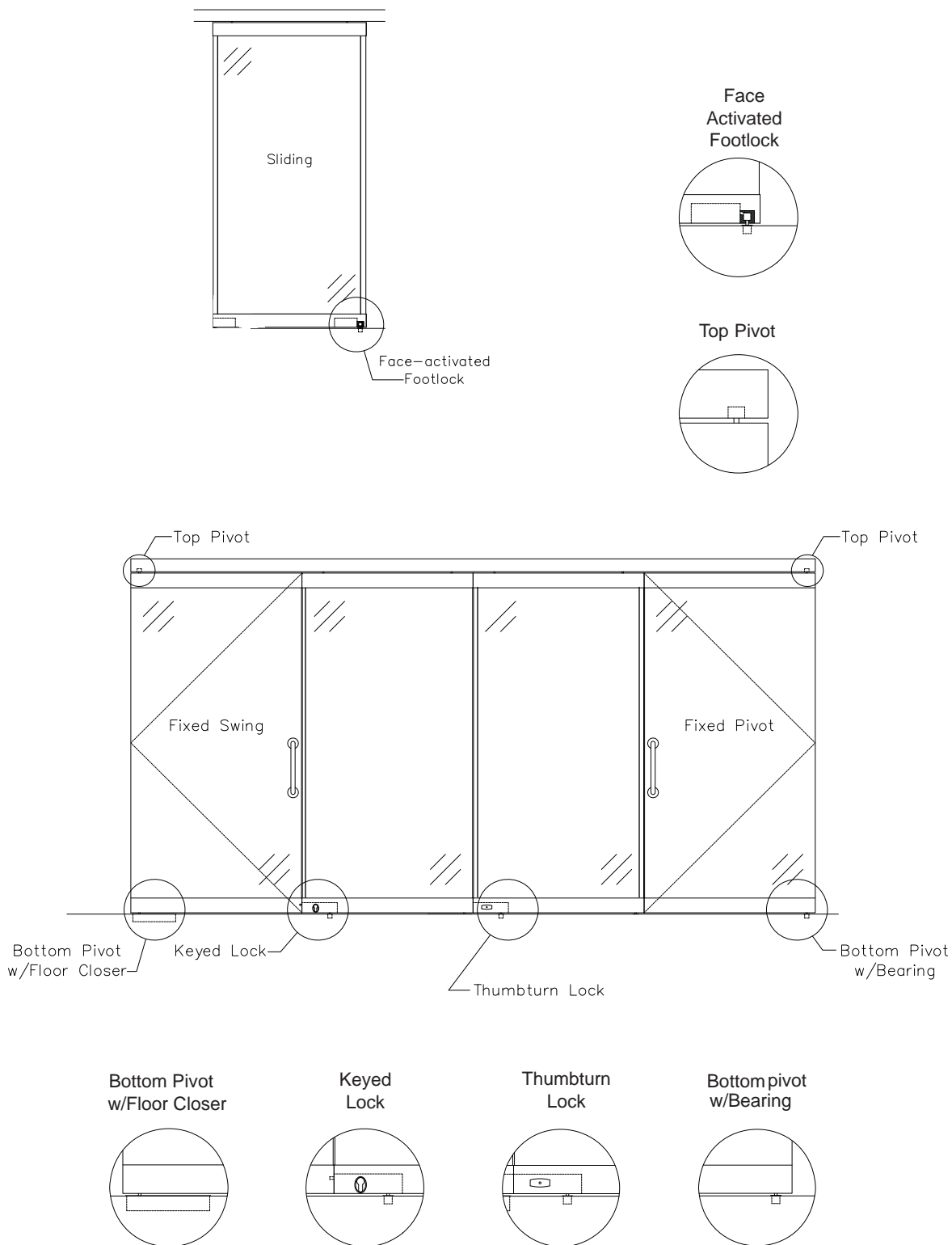

KWIK-WALL Offers a full complement of accessories for customizing any glass wall system to meet the specific needs of the most demanding project.

If you don't see the style or options and accessories you are looking for, KWIK-WALL has many other styles of Operable Glass Walls to bring you the solution to your space division needs.

This Product Selection Guide will step you through the various features of each model. Product stack arrangements and details show the more common elements for each model.

Model	APPLICATIONS		PRODUCT FEATURES						
	Interior	Exterior	Pivot Door	Sliding Pivot Panel	Sliding Swing Panel	Color Options	Trimmed Vertical Edge	Trimless Vertical Edge	Lock Options
Variotec Trimless	✓		✓	✓	✓	✓		✓	✓
Variotec Trimmed	✓		✓			✓	✓		✓
Variofold	✓		✓			✓		✓	✓
Centerfold	✓		✓			✓		✓	✓
KWV-Tec Trimless	✓		✓	✓	✓	✓		✓	✓
KWV-Tec Trimmed	✓		✓			✓	✓		✓
KWP-Fold	✓		✓			✓		✓	✓
KWV-Tec Trimmed Acoustical	✓		✓			✓	✓		✓

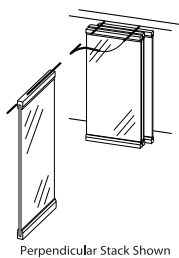

**Individual Panels - Perpendicular, Parallel, Remote or Custom Stack (Variotec, & KWV-Tec)**

Individual Panels are top supported by two (2) carriers that operate in the track system that allows panels to move and turn effortlessly through radius intersections that are engineered for heavy glass panels. The versatility of stack arrangements includes Perpendicular Stack, Parallel Stack, Remote or Custom Stack.

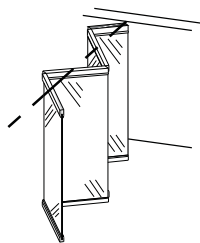

**Continuously Hinged Center Stack (Centerfold)**

Continuously Hinged Panels are hinged together to form a continuous panel train that allows for easy set-up. The Center Stack arrangement provides panel storage at one or both ends of the wall's installed position. The final closure panel is a half panel.

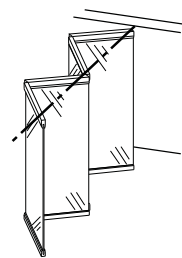

**Continuously Hinged - Offset Stack (Variofold)**

Continuously Hinged Panels are hinged together to form a continuous panel train that allows for easy set-up. The Offset Stack System allows panels to be stacked perpendicular to the main track & offset to the right or left.

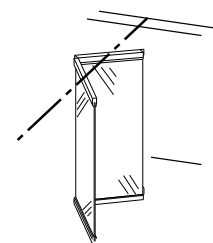

**Hinged Pairs Center Stack (KWP-Fold)**

Hinged Pairs Panels are panels hinged together in groups of two (2), unless otherwise specified. Panels are top-supported by one (1) carrier in each panel. The Center Stack arrangement provides panel storage at one or both ends of the wall's installed position.

KWIK-WALL Company warrants each glass wall and its component parts to be free from defects in material and workmanship for a period of five (5) years from date of delivery to the original purchaser, when installed by an authorized KWIK-WALL distributor. KWIK-WALL Company reserves the right to have authorized personnel inspect any part alleged to be defective and to refuse any returned material unless the return was previously authorized by KWIK-WALL. (Glass is specifically excluded from the warranty.)

This warranty does not apply to any damage or deterioration caused by abuse or failure to provide reasonable and necessary maintenance. All field applied finishes, accessories or product modifications are specifically excluded under this warranty. KWIK-WALL's liability hereunder is limited to the replacement of any partition or component part found to be defective. Labor charges are the responsibility of the customer.

***KWIK-WALL SHALL NOT BE LIABLE FOR ANY INCIDENTAL OR CONSEQUENTIAL DAMAGES. ALL OTHER WARRANTIES EXPRESSED OR IMPLIED INCLUDING ANY IMPLIED WARRANTY OF MERCHANTABILITY ARE HEREBY EXPRESSLY EXCLUDED.***

Some states do not allow the exclusion or limitation of consequential or incidental damages, so the above limitation or exclusion may not apply to you.

This warranty gives you specific legal rights, and you may also have other rights which vary from state to state

Note:

Due to ongoing research and development, some variation may occur in product specifications and design. Please refer to your actual KWIK-WALL shop drawing(s) for exact product dimensions and specifications.

***Distributed By:***

