

3020 GL TECHNICAL DATA

3000 Series Glass Insert panels, Multi-Directional
STC 43

KWIK-WALL... One Source for Wall Systems.

KWIK-WALL's 3000 Series - Steel Panel operable wall systems answer the challenge for space division needs posed by multi-purpose room layouts. Years of continuing research and development have produced many outstanding features!

The Model 3020GL - combines Insulated Glass with a welded steel frame to deliver superior durability and maximum sound control.

Multi-Directional wall systems consist of manually operated, individual panels that are suspended from a structural aluminum track which utilizes 90° "X," "L" and "T" intersections, allowing unlimited directional versatility.

SOUND CONTROL...

KWIK-WALL's 3020GL Series - Panel is an acoustically rated wall systems that is designed and manufactured to meet the most demanding sound control requirements. The 3020GL system has a Sound Transmission Class (STC) ratings of 43 STC tested and certified in an independent acoustical laboratory in accordance with ASTM E 90 and ASTM E 413 test procedures. The STC ratings represent a single number expression of the effectiveness of an operable wall in preventing the passage of transmitted sound in the range* of 125 Hz to 4,000 Hz.

For assistance with designing room division applications using Operable, Glass or Accordion wall systems, please contact your local KWIK-WALL distributor.

*The average human ear has an audibility range from 125 Hz to 4,000 Hz. Levels in excess of 65 dB to 70 dB are generally too loud for ordinary speech communication. When the sound pressure exceeds 120 dB, it normally passes the threshold of pain.

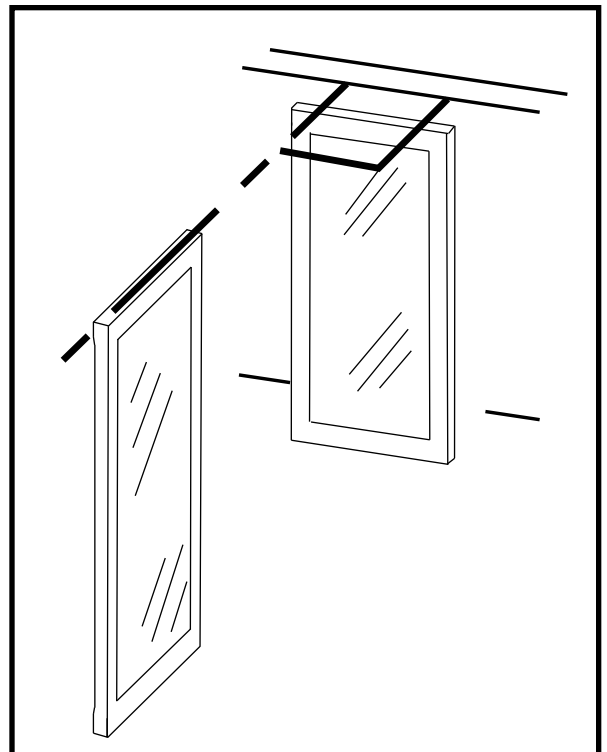

1.01 WORK INCLUDED

- A. Operable Wall System shall be furnished, installed and serviced by KWIK-WALL's authorized distributor, in compliance with the architectural drawings and specifications contained herein.

1.02 RELATED WORK

- A. Structural Support: Structural support system required for suspending the operable wall shall be designed, installed and pre-punched by others, in accordance with ASTM E 557 and KWIK-WALL's shop drawings.
- B. Insulation: Sound insulation and baffles for the plenum area above the track system, under the permanent floor, inside air ducts passing over or around the operable wall, and in permanent walls adjoining the operable wall system shall be by others, in accordance with ASTM E 557.
- C. Opening Preparation: Proper and complete preparation of the operable wall system opening shall be by others in accordance with ASTM E 557, and shall include floor leveling; plumbness of adjoining permanent walls; substrate and / or ceiling tile enclosures for the track system; and the painting and finishing of trim and other materials adjoining the head and jamb areas of the operable wall. Any permanent wall(s) receiving an adjustable or fixed wall jamb will require internal structural blocking in order to secure the jamb to the permanent wall. Refer to a copy of the shop drawings for additional details.

1.03 SYSTEM DESCRIPTION

- A. The operable wall system shall consist of Individual Panels that are top supported by two (2) multi-directional carriers that are capable of negotiating 90° "X", "L" and "T" intersections.
- B. The operable wall system shall consist of acoustically rated panels tested in accordance with ASTM E 90 and ASTM E 413 test procedures, and shall have achieved a STC rating as specified herein (see "Acoustical Performance" article listed under Part 2 – Products).

1.04 QUALITY ASSURANCE

- A. The operable wall shall have been tested in an independent acoustical testing laboratory in accordance with ASTM E 90 and ASTM E 413 test procedures.
- B. The operable wall panel construction and finish materials shall consist of Class A rated materials in accordance with ASTM E 84.
- C. The operable wall shall be installed by KWIK-WALL's authorized distributor in accordance with ASTM E 557.

1.05 REFERENCES

- A. ASTM E 90: Laboratory Measurement of Airborne-Sound Transmission Loss of Building Partitions.
- B. ASTM E 413: Determination of Sound Transmission Class (STC).
- C. ASTM E 557: Architectural Application and Installation of Operable Partitions.
- D. ASTM E 84: Surface Burning Characteristics of Building Materials.
- E. ASTM A 653: Specification for General Requirements for Steel Sheet, Alloy-Coated (Galvannealed) by the Hot Dip Process.

- F. ASTM C 423: Standard Test Method for Sound Absorption and Sound Absorption Coefficients by the Reverberation Room Method.
- G. CCC-W-408A: Federal Specification which applies to Vinyl Coated Wall Coverings.
- H. CFFA-W-101-D: Chemical Fabrics and Film Association Quality Standard for Vinyl Coated Fabric Wall Coverings.
- I. ATT M E 2190: Certification and testing for Insulated Glass inserts.

1.06 SUBMITTALS

- A. KWIK-WALL shall provide written technical information and related detail drawings, which demonstrate the products comply with contract documents for each type of operable partition specified.
- B. KWIK-WALL shall provide detailed engineering drawings featuring track plan, panel elevation, horizontal and vertical details and beam punching template as required.
- C. KWIK-WALL shall provide written test report of the independent acoustical testing laboratory certifying the attainment of the specified STC rating, upon request.
- D. KWIK-WALL shall provide written instructions specifying the proper operation and maintenance of the operable wall system.
- E. KWIK-WALL shall provide a color selector demonstrating KWIK-WALL's selections of the specified finish material. Samples shall consist of actual swatches of the specified finish material.

1.07 DELIVERY, STORAGE AND HANDLING

- A. Panels shall be individually wrapped in a protective plastic covering to keep panels clean during delivery, storage and handling.
- B. Panels shall be stored on edge and above the floor on cushioned blocking in a dry and ventilated area, protected from humidity and temperature extremes.

1.08 SEQUENCING / SCHEDULING

- A. Beam Punching: KWIK-WALL shall provide beam punching template drawing detailing the anchor locations for the suspended track system (as required for Drop Rod Mounting), as required for the fabrication and installation of structural overhead support by others.
- B. Track Installation: Scheduling of operable wall track installation shall occur after structural overhead support has been properly and completely fabricated and installed by others.
- C. Panel Installation: Operable wall panel installation shall occur after fixed wall substrate construction is properly and completely installed by others, as required to protect panels from ongoing adjacent construction.

1.09 WARRANTY

- A. KWIK-WALL shall warrant each operable wall panel and its component parts to be free from defects in material and workmanship for a period of five (5) years from the date of delivery to the original purchaser, when installed by an authorized KWIK-WALL distributor. KWIK-WALL also warrants the fixed top seals, track, carriers, and its component parts to be free from defects in material and workmanship for a period of ten (10) years. (see actual warranty on Page 12 for details and limitations). (Glass is specifically excluded from the warranty.)

2.01 ACCEPTABLE MANUFACTURER

A. Operable walls shall be Series 3000, Model 3020GL Individual Panels /Multi-Directional as manufactured by KWIK-WALL Company.

2.02 PANEL CONSTRUCTION

A. Panel Dimensions: Standard panel dimension shall be a nominal 4" [101.6] thick.

B. Panel Frame: Steel frame shall be 16-gauge galvalneal steel; horizontal top cross member shall be minimum 12-gauge galvalneal steel which meets or exceeds ASTM A 653 requirements. Frame shall be all-welded construction and shall be Class A rated, fire retardant, non-combustible and non-corrosive in accordance with ASTM E 84. Panel frame shall be designed to accept two (2) pieces of 1/4" [6.35], thick glass in opening cut out. (Glass opening size will vary based on panel height and width. Refer to shop drawings for sizes.)

C. Panel Skins: Panel skins shall be Class A rated (except Wood Veneer and High Pressure Laminate) in accordance with ASTM E 84. Panel skin material shall consist of (select):

1. Standard Acoustical Substrate: consisting of structural acoustical substrate pressure laminated to both sides of the steel frame to form a rigid, unitized and structural panel.
2. Optional Steel Skins: consisting of minimum 22-gauge tension-leveled galvalneal steel, pressure laminated to a structural acoustical backer and mechanically fastened to the steel frame to form a rigid, unitized and structural panel.
3. Optional Wood Veneer: consisting of particle board core covered with wood veneer and pressure laminated to both sides of the steel frame to form a rigid, unitized and structural panel.
4. Optional High Pressure Laminate: consisting of particle board core covered with general purpose plastic laminate and phenolic backer sheet, which is pressure laminated to both sides of the steel frame to form a rigid, unitized and structural panel.

D. Glass: Opening cut out in panel shall be glazed with insulated glass that is manufactured in accordance with ASTM E 2190. Glass type shall be an acoustical insulated glass unit 1 3/4" [44.5] thick with 1" [25.4] air space. Glass shall be retained in opening cut out using an aluminum extrusion.

E. Panel Weight: Maximum panel weight shall be 11.3 - 12.3 lbs./ft.² (55 - 60.5 kg/m²) depending on STC rating, size and options selected.

2.03 OPERATION

A. Operation shall be Individual Panels with a Multi-Directional track system that allows the panels to negotiate 90° "X", "L" and "T" intersections as required for movement of panels from storage location(s) to various installed positions. Panels shall be top supported by two (2) carriers featuring dual horizontal precision bearings with high strength polymer tires riding on a structural aluminum track.

2.04 STACK ARRANGEMENTS

A. Stack Type: Panel storage configuration shall be (select):

1. Standard Perpendicular Stack: consisting of panels stacked perpendicular to the wall's installed position.

2. Optional Parallel Stack: consisting of panels stacked parallel to the wall's installed position.

3. Optional Remote Stack: consisting of panels located remotely from the wall's installed position, as shown on submitted shop drawings.

B. Stack Quantity: Panels shall be stored in separate stack areas as required for panel storage.

2.05 FINISHES

A. Finish Material Type: Panel finish material shall be Class A (except wood veneer) rated in accordance with ASTM E 84, consisting of (select):

1. Vinyl: consisting of Type II, reinforced vinyl weighing 21 oz./lin. yd. (651 g/lin. m). Vinyl shall meet or exceed CCC-W-408A and CFFA-W-101-D quality standards.
2. Optional Upgrade Fabric: consisting of fade and tear resistant fabric that resists water-based stains weighing 13 oz./lin. yd. (403 g/lin. m).
3. Optional Basics Carpet: consisting of acoustically absorbent, non-woven needle punch fibers fused to prevent fraying and unraveling of material weighing 28.5 oz./lin.yd. (884 g/lin.m). Basics Carpet shall achieve a minimum NRC rating of .20 (applied over gypsum substrate) accordance with ASTM C 423.
4. Optional Upgrade Carpet: consisting of acoustically absorbent, non-woven needle punch fibers fused to prevent fraying and unraveling of material weighing 23 oz. / lin. yd. (713 g / lin. m). Upgrade Carpet shall achieve a minimum NRC rating of .25 (applied over gypsum substrate) in accordance with ASTM C 423.
5. Optional Wood Veneer: consisting of unfinished flat cut wood veneer laminated to 1/2" [12.7] thick particle board core. Veneer shall be book / running matched within a panel, and vertically edge banded if Trimless astragals are specified.

Notes: Optional Class "A" rated particle board is available. Acoustical substrate STC ratings apply for Wood Veneer panel construction.

6. Optional High Pressure Laminate: consisting of general purpose plastic laminate pressure bonded to 1/2" [12.7] particle board core, and edge banded if Trimless astragals are specified.

(Note: Acoustical substrate STC ratings apply for High Pressure Laminate panel construction.)

7. Optional Unfinished: consisting of panels with exposed acoustical substrate or steel skins for field applied wall covering or painting.

B. Finish Material Supplier: Finish material shall be (select):

1. Standard Factory Supplied: from manufacturer's standard selection of finish materials, as specified.
2. Optional Customer Supplied: from customer's selection of finish material, by others, and as approved by KWIK-WALL Company.

- C. Finish Material Application: Finish material shall be (select):
1. Standard Factory Applied: by KWIK-WALL's authorized distributor. Customer supplied finish material samples must be submitted to Kwik-Wall for testing and approval prior to acceptance and application.
 2. Optional Field Applied: by others.

2.06 PERIMETER TRIM AND SEALS

- A. Vertical Trim and Seals: Panels shall have vertical astragals containing flexible vinyl seals and incorporate reversible tongue-and-groove type configurations for positive interlocking with adjacent panels. Vertical astragal type shall be (select):
1. Standard Trimless Astragal: consisting of an aluminum extrusion with tongue-and-groove type vertical astragals. Vertical trim shall not be permitted on the panel faces, resulting in a minimal groove appearance between adjacent panels.
 2. Optional Cap-type Astragal: consisting of an aluminum extrusion with tongue-and-groove type vertical astragals for encapsulating and protecting the finish material and substrate along the vertical edge of the panel.
- B. Horizontal Top Trim and Seals: Top seals shall consist of flexible vinyl sweep seals installed on both sides of the panel. The seals shall consist of a compressed bulb between two (2) fingers of vinyl. Top seal type shall be (select):
1. Standard Fixed Top Seals: consisting of continuous-contact flexible vinyl sealing against the bottom flange of the overhead track.
- C. Horizontal Bottom Trim and Seals: Bottom seals shall consist of multiple fingers of flexible vinyl for positive contact and sealing with various floor surfaces. Bottom seal type shall be (select):
1. Standard Adjustable Bottom Seals: consisting of field adjustable, continuous-contact vinyl sweep seals with 2" [50.8] nominal height with 3/4" [19] of adjustment.
 2. Optional Operable Bottom Seals: consisting of an edge activated seal using a removable wrench as supplied by KWIK-WALL. Bottom seals shall provide 2" [50.8] of nominal travel.
 3. Optional Automatic Bottom Seals: consisting of self-activated seals providing 1 1/2" [38] of nominal travel
- D. Horizontal and Vertical Panel Trim: All exposed panel trim and hinges shall be of one (1) similar color (select):
1. Dark Bronze
 2. Grey

2.07 CLOSURE SYSTEMS

- A. Initial Closure System: The lead panel (the first panel exiting the stack) shall form a seal vertically against a rigid wall surface, as accomplished by a (select):
1. Standard Bulb Seal: consisting of continuous-contact, flexible vinyl bulb seals installed along the vertical edge of the lead panel for positive compression against a rigid wall surface.

2. Optional Fixed Starter Jamb: consisting of an aluminum extrusion, which is permanently mounted to a structural wall surface. The Fixed Starter Jamb shall incorporate a tongue-and-groove type vertical astragal for positive interlocking with the lead panel.
 3. Optional Adjustable Starter Jamb: consisting of an aluminum extrusion which is permanently mounted to a structural wall surface and is field-adjustable to compensate for out-of-plumb conditions of the fixed wall. The Adjustable Starter Jamb shall incorporate a tongue-and-groove type vertical astragal for positive interlocking with the lead panel.
- B. Final Closure System: The final closure panel (the last panel exiting the stack) shall form a seal vertically against a rigid wall surface. The type of final closure panel shall be (select):
1. Standard Hinged Panel(s) Closure: consisting of a panel hinged Permanently and directly to a structural wall surface. The Hinged Panel(s) shall be equipped with an adjustable bottom seal, a lap-type extrusion for sealing against its adjacent panel (standard) or (optional) expander mechanism with a nominal 5" [127] of travel, and a flush pull handle on each side of the panel.
 2. Optional Expander Panel Closure: consisting of an expander mechanism with a nominal 5" [127] of travel, activated from the face of the panel using a removable wrench as supplied by manufacturer. The Expander Panel shall be equipped with an adjustable bottom seal (standard) or (optional) operable bottom seal, and a flush pull handle.
- Note: Optional Automatic Bottom Seal is not available in conjunction with Final Closure panel(s).
3. Optional Pocket Door(s): (see "Series 3000 Pocket Door" brochure for complete details and specifications).

2.08 ACOUSTICAL PERFORMANCE

- A. Certification: The operable wall shall have been tested in an independent acoustical testing laboratory in accordance with ASTM E 90 and ASTM E 413 test procedures.
- B. STC Rating: The operable wall acoustical performance rating shall be based on (select):
1. Standard acoustical substrate: with a standard rating of 43 STC

2.09 PANEL ACCESSORIES

- A. Accessories including Pass Doors; Single or Double, Concealed Door Closures, Room Viewers, Exit Signs, Dry Marker Writing Surfaces, Recessed Eraser Trays, Vision Lites, Tack Surfaces and Pocket Doors shall be compatible with other accessories and options, furnished and installed by the operable wall manufacturer as noted on submitted shop drawings.

2.10 TRACK SYSTEMS

A. Track Type: The operable wall track system shall be extruded from structural aluminum alloy, which prohibits deterioration caused by rust or corrosion. The aluminum track shall have a durable anodized clear satin finish, which resists color fading and flaking. The track shall utilize grooves and interlocking steel pins for positive alignment of adjacent track sections. The track joints shall be reinforced overhead by a heavy-duty steel bracket made of hot-rolled, 3/8" [10] thick plate steel. Aluminum track shall include an integral nut slot to accept a hardened steel square nut to facilitate attachment of each steel all-rod and splice brackets to the overhead structural support.

B. Track Size: The track size shall be (selected from Track and Carrier Selection Chart - refer to Page 7):

1. Type 425 Multi-Directional Aluminum Track: certified to be capable of supporting up to 525 lb. (238 kg) of total live load weight per panel.
2. Type 850 Multi-Directional Aluminum Track: certified to be capable of supporting up to 850 lb. (386 kg) of total live load weight per panel.

2.11 CARRIER SYSTEMS

A. Carrier Type: Each Individual Panel shall be top supported by two (2) carriers utilizing a 5/8" [16] diameter pendant bolt. Each carrier shall consist of dual horizontal, permanently lubricated, precision ground steel bearings with high strength polymer tires as required for smooth and quiet operation. Multi-Directional carriers shall be capable of negotiating 90° "X", "L" and "T" intersections as required for moving panels from storage location(s) to various installed positions.

B. Carrier Size: The carrier size shall be (select from Track and Carrier Selection Chart - refer to Page 7):

1. Type 425 Multi-Directional Carrier: certified to be capable of supporting up to 525 lb. (238 kg) of total live load weight per panel.
2. Type 850 Multi-Directional Carrier: certified to be capable of supporting up to 850 lb. (386 kg) of total live load weight per panel.

2.12 SUSPENSION SYSTEMS

A. Mounting Systems: The track shall be supported by (select):

1. Standard Drop Rod Mount: consisting of adjustable rods of grade 2, 3/8" [10] diameter threaded steel all-rod provided with 3/8" [10] serrated steel nuts.
2. Optional Direct Mount: consisting of 3/8" [10] x 3" [76] lag screws for attachment to an overhead structural (wood) support. (Direct Mount track installations should not exceed 425 lb. (193 kg) of panel weight.)
3. Optional Drop Rod Bracket Mount: consisting of 3/8" [10] thick steel brackets mounted to top of track and supported with adjustable rods of grade 2, 3/8" [10] diameter threaded steel all rod provided with 3/8" [10] serrated steel nuts.

MODEL 3020GL PRODUCT GUIDE <i>Standard Acoustical Substrate Construction</i>				
STC Rating	Panel Thickness (nominal)	Max. Panel Weight lb./ft. ²	Maximum Panel Height	Maximum Wall Width
43	4" [101.6]	11.3 (55 kg/m ²)	16' - 2" [4.93m]	unlimited

MODEL 3020GL PRODUCT GUIDE <i>Optional Steel Skin Construction</i>				
STC Rating	Panel Thickness (nominal)	Max. Panel Weight lb./ft. ²	Maximum Panel Height	Maximum Wall Width
43	4" [101.6]	12.3 (60.5 kg/m ²)	24' - 2" [3.37m]	unlimited

Notes: Optional Class "A" rated particle board is available. Acoustical substrate STC ratings apply for Wood Veneer panel construction.

* For panel fabrication heights over 16' -2" [4.93] please contact KWIK-WALL Company for design assistance.

* Estimated panel weights are for intermediate panels. Weight may vary due to substrate, size, or function of panel. Add 105 lbs [47kg] for pass door. Add 6 lbs [3kg] per lin ft height for expanders. Add 3.5 to 8 lbs [1.6 to 3.6kg] per lin ft for track.

**Standard features can be modified, contact your Kwik-Wall distributor for the features you want.

*** Horizontal Splice: Heights over 14'2" [4.31] with Acoustical Substrate require a structural splice.

MODEL 3020GL - TRACK AND CARRIER SELECTION CHART											
PANEL SKIN TYPE	MAXIMUM PANEL WEIGHT lb. / ft. ²	STC RATING	PANEL FABRICATION HEIGHT*								
			Up to 8'-2" (2.49 m)	Up to 9'-2" (2.79 m)	Up to 10'-2" (3.10 m)	Up to 11'-2" (3.40 m)	Up to 12'-2" (3.71 m)	Up to 13'-2" (4.01 m)	Up to 14'-2" (4.32 m)	Up to 16'-2" (4.93 m)	Up to 24'-2" (7.37 m)
Acoustical Substrate	11.3 (55 kg/m ²)	43	425 Track & Carriers								
Steel Skin	12.3 (60.5 kg/m ²)	43	850 TRACK & CARRIERS								

*Based on 4' - 0" [1.22] Intermediate panel widths.

*For Panel fabrication heights over 16'2" (4.93m) please contact Kwik-Wall Company for design assistance.

3.01 INSPECTION

- A. Proper and complete preparation of the operable wall system opening shall be by others in accordance with the architectural drawings, KWIK-WALL's shop drawings and ASTM E 557. Any deviation of the actual opening from these specifications shall be called to the attention of the architect prior to the installation of the operable wall.
- B. Deficiencies in the operable wall opening shall be corrected by others prior to installation of the operable wall.

3.02 INSTALLATION

- A. The operable wall system shall be installed by KWIK-WALL's authorized distributor.
- B. The operable wall shall be installed in accordance with KWIK-WALL's written instructions, shop drawings and ASTM E 557 installation guidelines.

3.03 ADJUSTING AND CLEANING

- A. The operable wall panels and track system shall be adjusted and cleaned in accordance with KWIK-WALL's written instructions.

3.04 PROTECTION

- A. The operable wall panels shall be stored in the stacked (retracted) position prior to acceptance by the owner's representative.

3.05 DEMONSTRATION

- A. KWIK-WALL's authorized distributor shall demonstrate proper operation and explain proper and necessary maintenance requirements of the operable wall system to the owner's representative.

OPTIONS AND ACCESSORIES

For solid panels only - Not Glass Insert Panels

KWIK-WALL offers a full complement of accessories for customizing any operable wall system to meet the specific needs of the most demanding project.

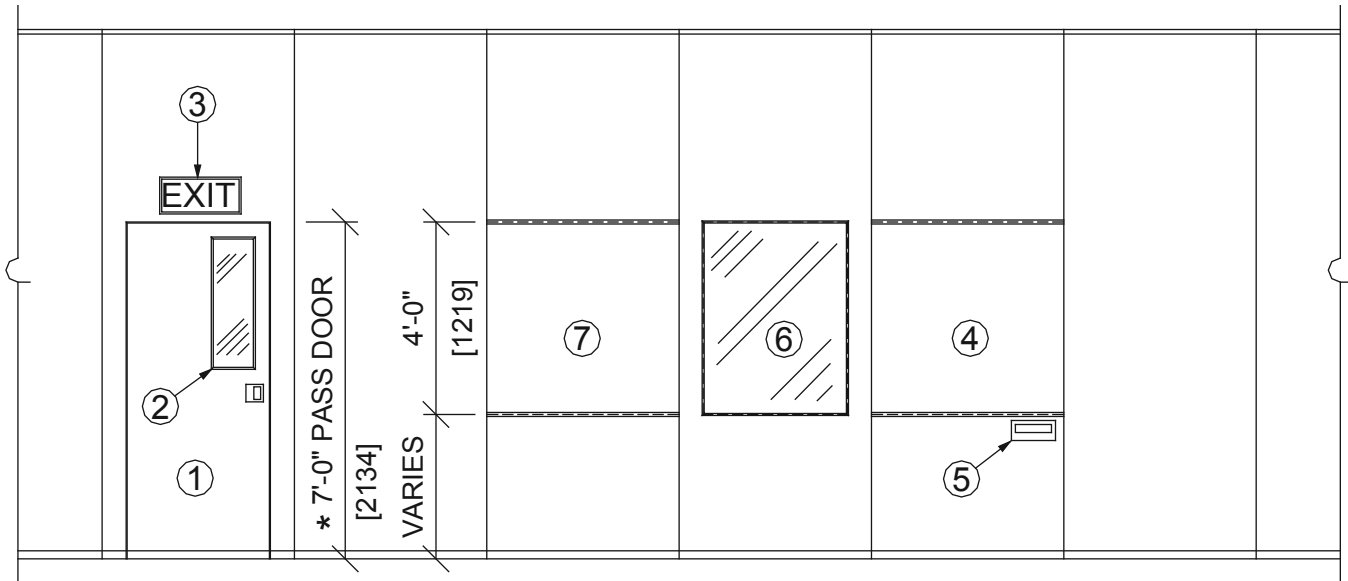

ACCESSORIES

- | | |
|---|----------------------------|
| 1. Pass Door * (Single shown, double available) | 5. Recessed Eraser Tray |
| 2. Pass Door Vision Lite | 6. Panel Vision Lite |
| 3. Exit Sign | 7. Tack Surface |
| 4. Writing Surface | 8. Pocket Door (Not shown) |

Notes:

- 1. 7' - 8" [2.34] minimum panel fabrication height required.
- 2. For complete specifications and details of KWIK-WALL Accessories, please visit our website at www.kwik-wall.com.

Optional Direct Mount

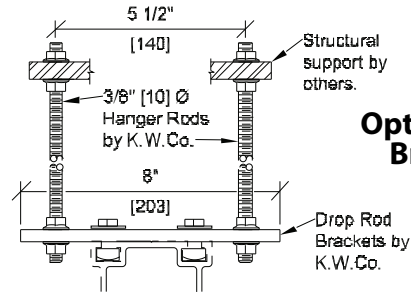
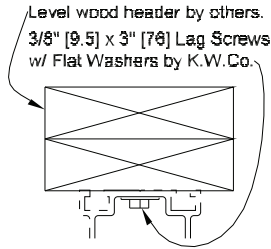

Optional Drop Rod Bracket Mount

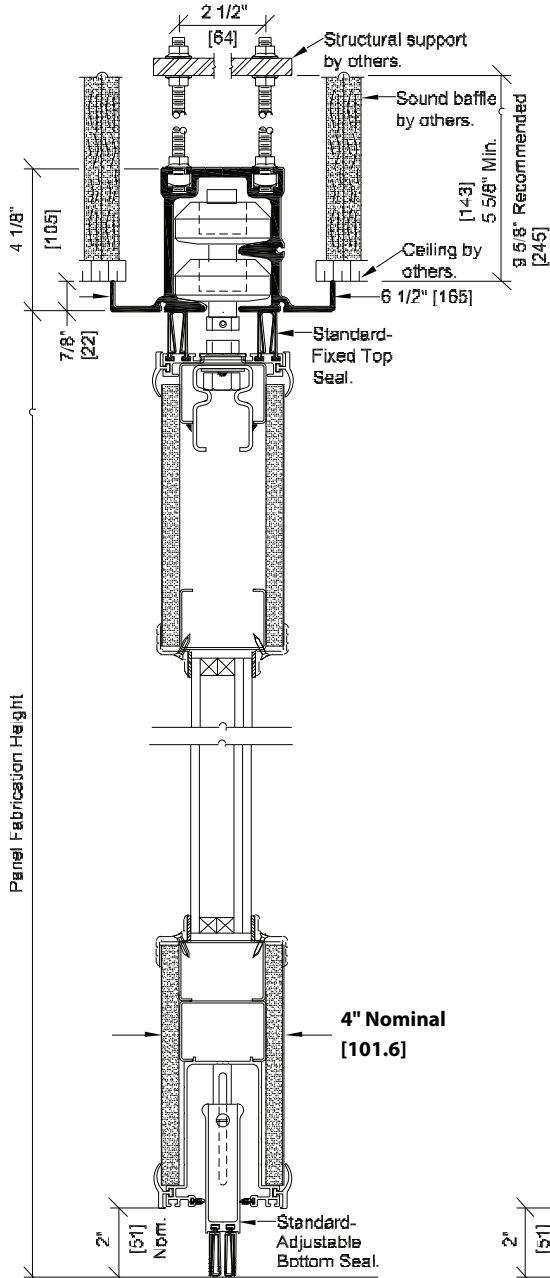

850 Multi-Directional Aluminum Track and Carrier

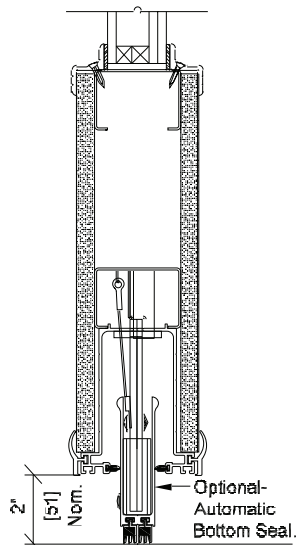

Optional Automatic Bottom Seal

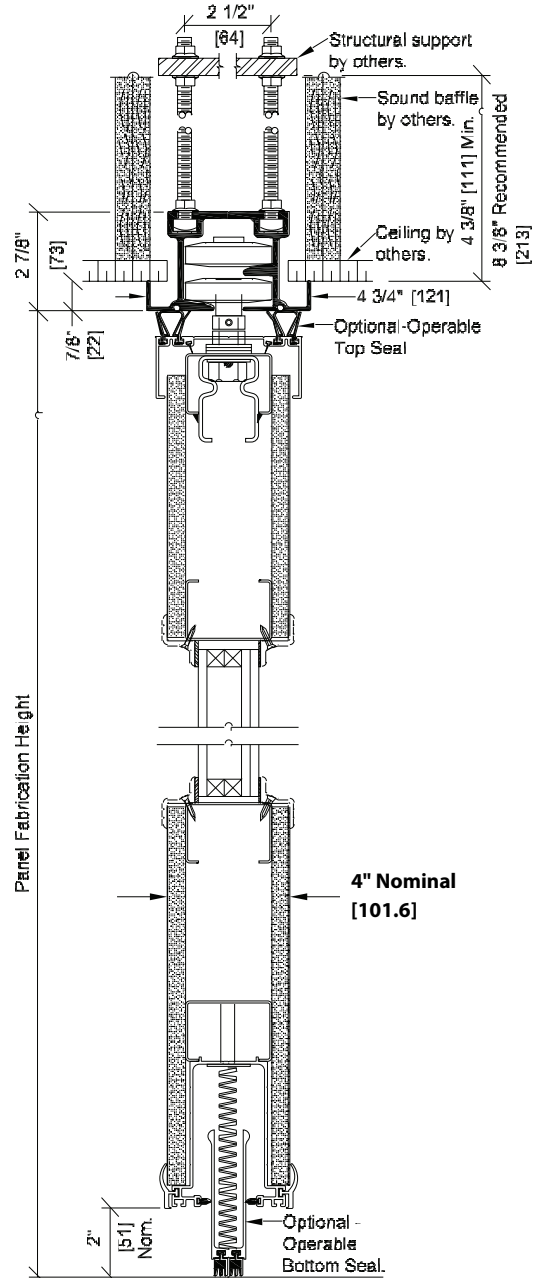

425 Multi-Directional Aluminum Track and Carrier

Notes:

1. Optional operable top seal requires standard operable bottom seal.
2. Optional automatic bottom seal is not available with final closure panel(s).

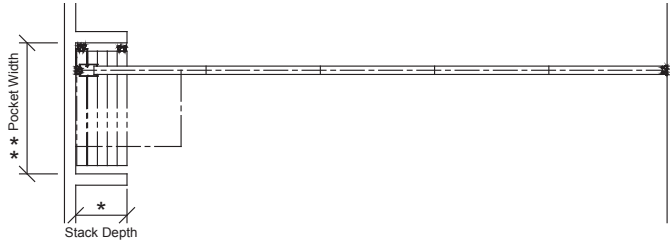

Standard Perpendicular Stack

Perpendicular stacking allows individual panels to be located at one (1) or both ends and stored perpendicular to the wall's installed position..

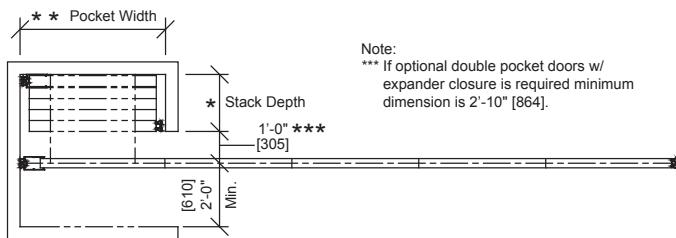

Optional Parallel Stack

In contrast to perpendicular stacking, Individual Panel arrangements may also be stored parallel to the wall's installed position, at one (1) or both ends..

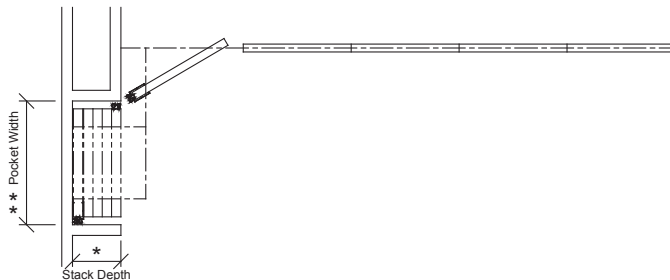

Optional Remote Stack

For more complex wall system layouts, or when space or other room constraints dictate, Individual Panels may be located remotely from the wall's installed position.

Stack Depth*

The overall depth of the stack area, as required for panel storage, is dictated by the total number of panels in the wall system. KWIK-WALL's Model 3020GL - Steel panels require an average stack depth of 4¹/₄" [108] per panel. To determine the stack depth, calculate as follows:

Number of Panels x 4¹/₄" [108]

*Note: Additional stack depth is required for wall systems containing the following type of panels:

- Expander Panel Closure or Pass Door Panel: 3³/₄" [19]
- Hinged Panel(s) Closure: 4" [102]
- Pocket Door(s): 6" [152]

**Note: For wall systems that include Pocket Doors, please reference KWIK-WALL's "3000 Series Pocket Doors" brochure for pocket layout dimensions and applications.

Pocket Width**

The width of the pocket is determined by the widest panel in the wall run. For specification purposes, assume the widest panel is 4'-0" (122cm) maximum. Wall systems that utilize Automatic type bottom seals will require extra pocket width to allow clearance for the actuator that protrudes from the bottom of the lead panel. Pocket width may be calculated as follows:

If Adjustable or Operable Bottom Seals are specified:

Panel Width + 7" [178]

(allows 3¹/₂" [89] for hand clearance on each side)

If Automatic Bottom Seals are specified:

Panel Width + 10" [254]

(for actuator clearance on one side)

plus

3¹/₂" [89]

(for hand clearance on one side)

Standard Expander Panel Closure

The final closure panel is equipped with an expander saddle located on the vertical edge of the panel that mechanically telescopes outward to create a positive contact seal with a rigid wall, pocket door or jamb. The expansion of the expander saddle is activated by inserting a wrench into an escutcheon plate located on the panel face. The expander panel is equipped with a flush pull handle and an adjustable bottom seal (standard) or (optional) operable bottom seal.

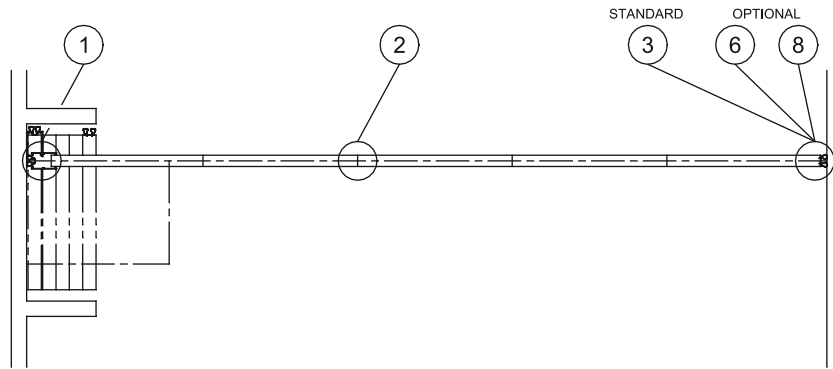

Optional Hinged Panel(s) Closure

This final closure configuration is accomplished by a panel(s) which is hinged permanently and directly to a structural wall member. The hinged panel(s) features adjustable bottom seals and includes a flush pull handle on each side of the panel.

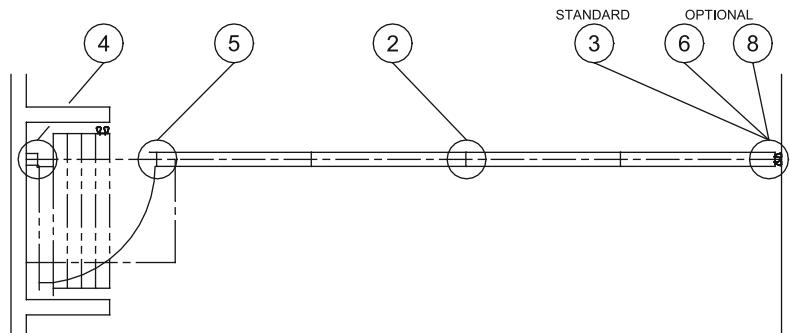

Optional Double Pocket Doors with Expander Closure

The pocket door is equipped with an expander mechanism in the same way as the more common expander panel. Rather than being located on a wall panel, the expander saddle is integrated into a pocket door panel. The saddle expander will be fully retracted with a pair of bulb seals compressed against the last panel exiting the stack. The pocket doors are provided with fixed bottom seals as a factory standard and includes a footbolt and flush pull handle.

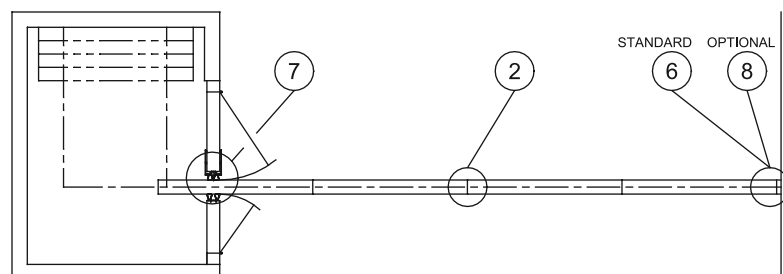

Note: Horizontal details for number 1-8 referenced above can be found on Pages 10 and 11.

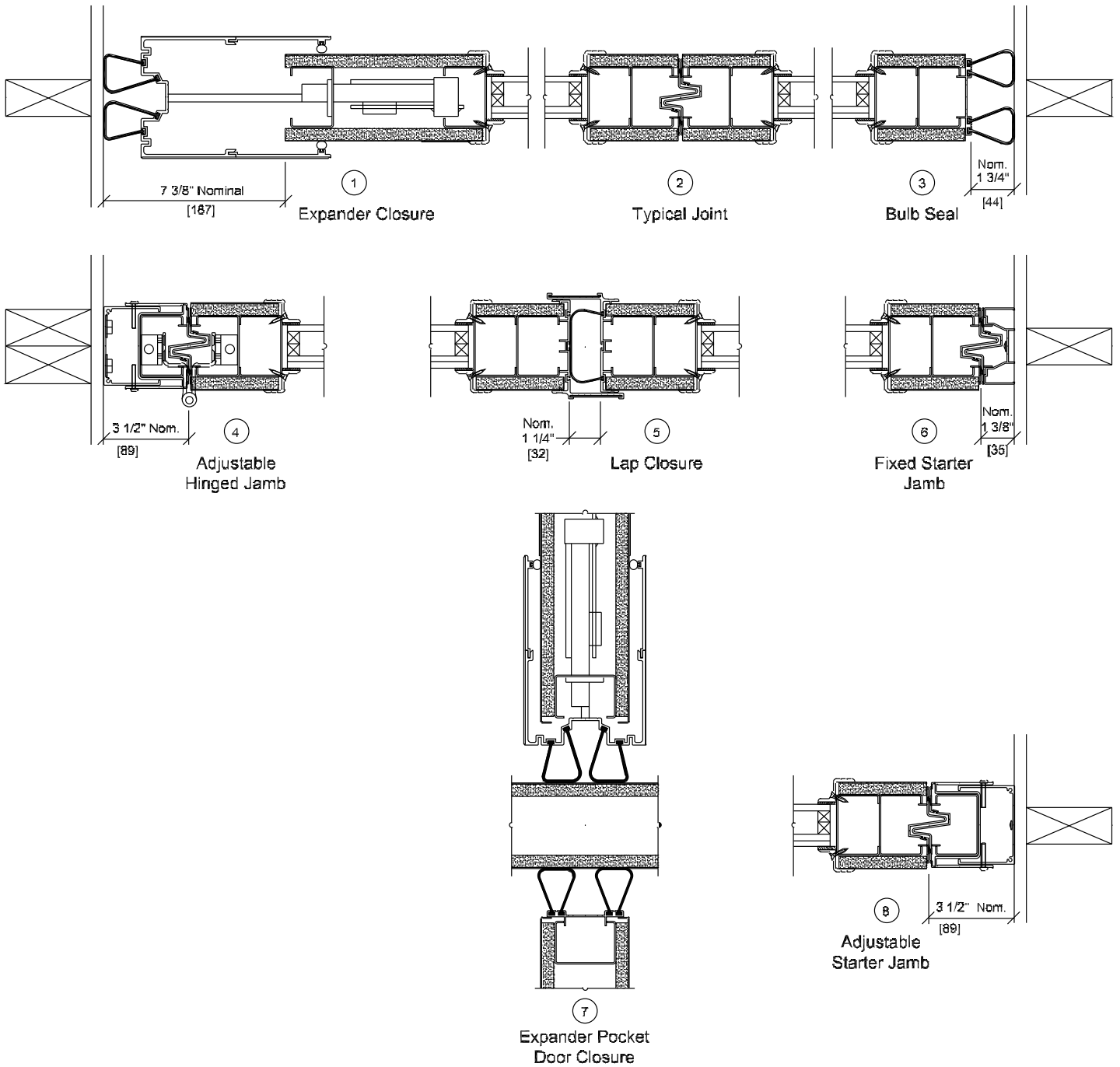

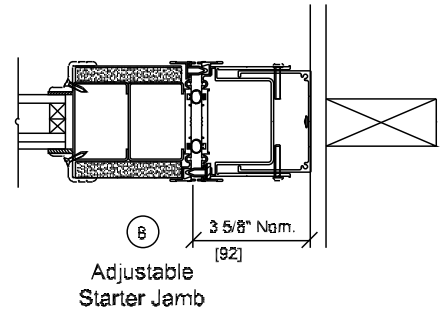
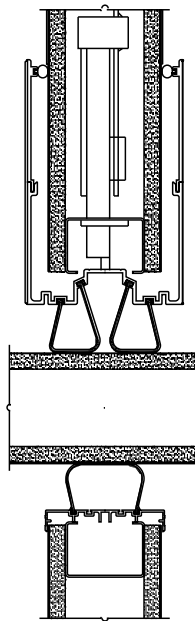
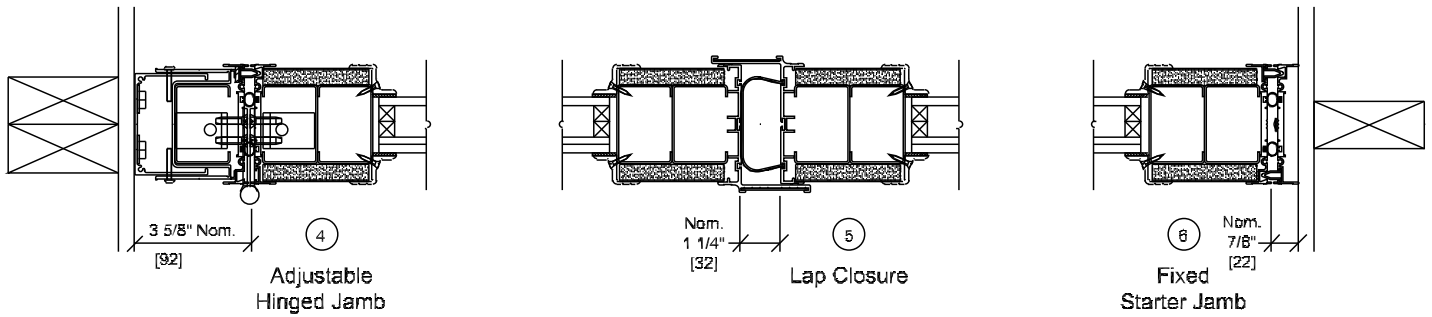
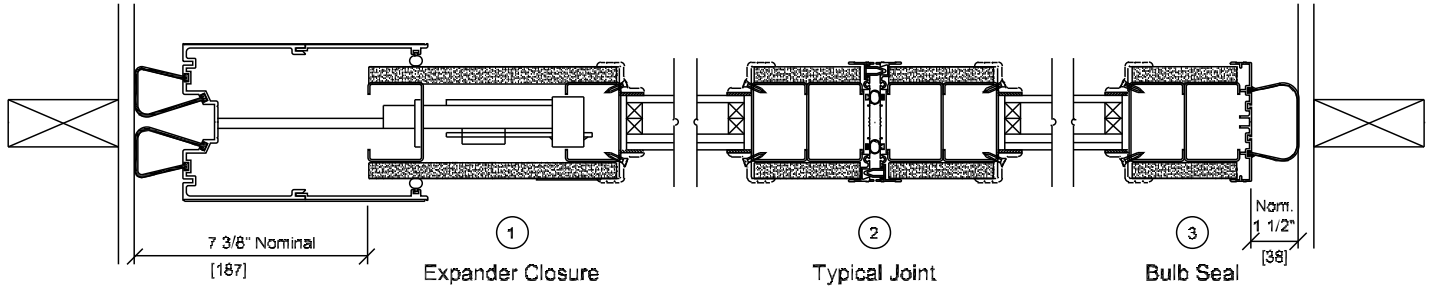

KWIK-WALL Company warrants each operable wall panel and its component parts to be free from defects in material and workmanship for a period of five (5) years from date of delivery to the original purchaser, when installed by an authorized KWIK-WALL distributor. KWIK-WALL also warrants the fixed top seals, track, carriers, and its component parts to be free from defects in material and workmanship for a period of ten (10) years. The Model 3050 electric wall because of its special track and carrier system will continue to carry the standard five (5) year warranty for all components. KWIK-WALL Company reserves the rights to have authorized personnel inspect any part alleged to be defective and to refuse any returned material unless the return was previously authorized by KWIK-WALL. (Glass is specifically excluded from the warranty.)

This warranty does not apply to any damage or deterioration caused by abuse or failure to provide reasonable and necessary maintenance. All field applied finishes, accessories or product modifications are specifically excluded under this warranty. KWIK-WALL's liability hereunder is limited to the replacement of any panel or component part found to be defective. Labor charges are the responsibility of the customer.

In order to keep the warranty valid, routine maintenance must be performed in accordance with manufacturer's specifications on the operable wall system. A maintenance log must be maintained indicating dates, type of service performed and the certified Kwik-Wall distributor who performed the service.

KWIK-WALL SHALL NOT BE LIABLE FOR ANY CONSEQUENTIAL OR INCIDENTAL DAMAGES. ALL OTHER WARRANTIES EXPRESSED OR IMPLIED INCLUDING ANY IMPLIED WARRANTY OF MERCHANTABILITY ARE HEREBY EXPRESSLY EXCLUDED.

Some states do not allow the exclusion or limitation of consequential or incidental damages, so the above limitation or exclusion may not apply to you. This warranty gives you specific legal rights, and you may have other rights, which vary from state to state.

Note:

Due to ongoing research and development, some variation may occur in product specifications and design. Please refer to your actual KWIK-WALL shop drawing(s) for exact product dimensions and specifications.

Distributed By:

